



INTERNATIONAL
MASONRY
INSTITUTE

Internal Bracing Design Guide for Masonry Walls Under Construction

Preface: Masonry under construction must be temporarily braced until the final lateral support system is in place. The importance of this bracing is paramount to the safety of both the general public and those involved with the project under construction. The *Standard Practice for Bracing Masonry Walls Under Construction* provides engineering principles and properties for rationally design bracing systems for masonry walls under construction. Internal bracing, or using the developing strength of the masonry assembly, can provide significant benefits to a project team. To support the engineering community in the use of structural masonry, including effective and efficient temporary bracing, the International Masonry Institute has funded this guide.

Date: May, 2013

1st edition

About Bracing Masonry Walls Under Construction (from International Masonry Institute)

This *Guide* has been developed by the International Masonry Institute (IMI) for use by engineers and other qualified persons designing masonry bracing systems. It provides an outline of the process and illustrates the application of engineering principles for bracing masonry walls using the wall's inherent strength rather than external bracing elements. This concept is known as 'Internal Bracing' and has been successfully applied in numerous projects with short to very tall walls.

Bracing masonry walls under construction is a life safety necessity that is mandated by each state's legally adopted building code through the referenced masonry standards. The 2011 '*Specification for Masonry Structures*' (TMS 602/ACI 530.1/ASCE 6) was adopted by the 2012 International Building Code for masonry construction and contains requirements for the mason contractor to 'Design, provide, and install bracing that will assure stability of masonry during construction.' Bracing is also part of federal occupational safety requirements including national regulations -- OSHA Safety and Health Regulations for Construction (CFR 29) Part 1926.706 and locally adopted regulations -- Michigan's MiOSHA Construction Standard Part 2, as an example. Bracing protects project workers as well as the general public who may access the site, be passing by, or even occupying adjacent facilities or spaces.

Masonry bracing is typically designed by an engineer retained by the project's mason contractor, although there is some movement in the industry to incorporate Internal Bracing capacity into the project's construction documents prepared by the Engineer of Record. There is an industry standard for bracing masonry walls: '*Standard Practice for Bracing Masonry Walls Under Construction*', 2012, sponsored by IMI and the Mason Contractors Association of America (MCAA) and published by MCAA. There also are compiled examples and technical literature available through industry sources as well as proprietary information for external bracing systems. This *Guide* applies the content of the *Standard* and other documents along with knowledge gained through experience to provide users with one approach to designing internally braced masonry walls.

About International Masonry Institute (IMI)

The International Masonry Institute offers quality training for craftworkers, professional education for masonry contractors and free technical assistance to the design and construction communities. IMI is a strategic alliance between the International Union of Bricklayers and Allied Craftworkers (BAC) and their signatory contractors to promote quality masonry construction.

Team IMI consists of architects, engineers, construction managers, skilled craftworkers and instructors, offering what no other group can: expertise in training, craftsmanship, design, installation and marketing. That means buildings built by union craftworkers and contractors get built the right way.

Author

Scott W. Walkowicz, PE, NCEES
scott@walkowiczce.com

Walkowicz Consulting Engineers, LLC

Disclaimer

IMI and Walkowicz Consulting Engineers, LLC disclaim all warranties, expressed or implied, including but not limited to implied fitness for a particular purpose, with respect to this manual. All designs resulting from the processes defined in this manual should be verified to the user's satisfaction. The contents of these written materials may include technical inaccuracies or typographical errors and may be revised without notice.

This document is intended for the use of industry professionals who are competent to evaluate the significance and limitations of the information provided herein. This publication should not be used as the sole guide for masonry Internal Bracing design and construction.

Thanks

IMI and Walkowicz Consulting Engineers, LLC would like to thank Dailey Engineering, Inc., Bergmann Associates, Davenport Masonry and Koch Masonry for their willingness to share ideas based on their work with internally braced masonry walls under construction and for photographs and figures shared to better illustrate the concepts presented herein. Additional thanks are extended to Dailey Engineering and Bergmann Associates for their time and effort spent reviewing this document.

Internal Bracing Design Guide for Masonry Walls Under Construction

Table of Contents:

Table of Figures:	1
Section 1: Concepts for Bracing Masonry Walls Under Construction	2
1. General.....	2
2. External Bracing	2
3. Internal Bracing	2
4. Communication Between the Engineer and the Mason Contractor	3
5. Modifying Requirements Shown in the Construction Documents	5
6. The Role of Special Inspection.....	6
Section 2: Short Term Design Approach	7
1. General.....	7
2. Masonry	9
3. Foundation and Soils	10
Section 3: Internal Bracing Design	12
1. Analysis	12
2. Deliverables	13
Section 4: Design Examples	16
1. Component Software (Structural Masonry Design System, V5.0.1)	17
2. Finite Element (Ram Elements)	22
Section 5: Concluding Remarks.....	26

Table of Figures:

Figure 1: Cantilevered Wall Diagram.....	7
Figure 2: Sample Bracing Plan Graphics, Notes and Legend.....	15
Figure 3: Design Basis Menu – Codes tab.....	17
Figure 4: Design Basis Menu – Concrete Masonry tab	17
Figure 5: Out of Plane Wall Design – Design Data tab	18
Figure 6: Out of Plane Wall Design – Construction Data tab.....	18
Figure 7: Out of Plane Wall Design – Load Data tab	19
Figure 8: Analysis Results – Interaction Diagram Showing Insufficient Capacity	19
Figure 9: Return to Design Basis – Modify masonry strength	20
Figure 10: Analysis Results – Interaction Diagram Showing Sufficient Capacity.....	21
Figure 11: Data Input Field - Masonry Properties	22
Figure 12: Data Input Field - Geometry	22
Figure 13: Data Input Field - Masonry Criteria	23
Figure 14: Data Input Field - Loads.....	23
Figure 15: Data Input Field – Design Data	24
Figure 16: Analysis Report – Good bar size, excessive bar spacing	24
Figure 17: Analysis Report – Good bar size and spacing.....	25

Table of Photographs:

Photograph 1: External pipe braces utilized on a masonry wall under construction.....	2
Photograph 2: Masonry walls under construction utilizing Internal Bracing.	3

Section 1: Concepts for Bracing Masonry Walls Under Construction

1. General

Bracing masonry walls under construction requires predictable capacity to resist defined loads that may occur due to wind during construction and before the wall's final lateral support is in place. Applying rational engineering methods using material properties provides the basis for bracing design whether the masonry walls are braced in the traditional manner using external components or by Internal Bracing, that is, the more recent method of using the constructed masonry's inherent strength to provide stability during wall construction. It is important to realize that Internal Bracing provides verifiable engineering capacity and performance similar to systems that incorporate external bracing components and provides tangible benefits to the project that will be discussed later in this *Guide*.

2. External Bracing

While not the focus of this *Guide*, it is important to note that masonry walls can be braced using external components. External bracing has been used effectively for years and can provide appropriate capacity for masonry walls under construction and it may be necessary for certain masonry wall configurations that cannot be adequately braced using the wall's internal capacity. Advantages of this system include familiarity, visible components and the availability of numerous proprietary systems which are readily available. Disadvantages of this system may include lack of sufficient capacity due to improper construction or installation, inappropriate consideration given to wall connections and base anchorage, interference with and exposure to damage from site traffic and activities (for



Photograph 1: External pipe braces utilized on a masonry wall under construction with anchorage to block pallet 'skids' and column foundations. (Credit: Davenport Masonry, Holt, MI)

example: construction equipment running into braces or their anchorage, trades removing braces such as steel erectors needing to set roof structure or electricians or plumbers needing to install trenches for underground utilities and more), mobilization and de-mobilization time and expense, material acquisition/rental and storage expense as well as the need for anchorage connection to something with sufficient capacity to resist the loads imparted from the brace. External bracing is, however, an engineered system with a long track record of successful implementation that provides good value to the project team and the building owner.

3. Internal Bracing

This *Guide* presents a newer method for bracing masonry walls under construction: *Internal Bracing*. This method provides a highly effective and efficient method to provide stability to



Photograph 2: Masonry walls under construction utilizing Internal Bracing. (Credit: Koch Masonry, Dexter, MI)

masonry walls prior to the installation of, and connection to, the permanent lateral support system. This new method is based on using conventional masonry analysis methods, either Allowable Stress Design or Strength Design, derived from the *'Building Code Requirements for Masonry Structures.'* (TMS 402/ACI 530/ASCE 5), referred to as the "Code" hereafter. The analysis is conducted with modified criteria, specifically the masonry properties, based on green masonry system performance. The design method and criteria are found in the *'Standard Practice for Bracing Masonry Walls Under Construction'* – herein referred to as the "Standard" The *Standard* was first

published in 1999. It was revised in 2001 and again in 2012. The methods for Internal Bracing presented in this *Guide* are based on the 2012 *Standard*. The basic premises for analysis is cantilevered behavior, reduced masonry strengths, and full steel tensile strength after the grout has cured for either 12 or 24 hours, depending on the length of lap used. Advantages of this system include greater safety due to the lack of elements that could be impacted by site traffic or activities since there are no external braces, no additional mobilization or de-mobilization time, a more open, less complicated site without interferences to site traffic or construction activities, no external components including connectors, braces and foundations and none of the associated costs for those items. Other significant benefits found through using Internal Bracing are more predictable capacity (since there are no concentrated loads at brace top support points and a more direct load resistance path), and capacity that increases with time providing additional safety until the final lateral support system is installed. Disadvantages associated with the method may include unfamiliarity, the lack of external components that can be observed and inspected, lack of capacity due to improper construction and an occasional lack of design capacity based on configuration constraints which could lead to required modifications to the proposed construction and/or the application of external braces. However, Internal Bracing is an engineered method and it is believed that it provides better value to the project team and the end user.

4. Communication Between the Engineer and the Mason Contractor

It is imperative that the bracing design engineer understand several key aspects of the specific masonry construction. The masonry capacity and the demand placed on the wall and bracing depend on the manner and sequencing of the wall's construction and of surrounding construction. To facilitate this understanding one or more meetings are often held between the bracing design engineer and mason contractor. Points that can influence Internal Bracing capacity analysis include:

Masonry Layout

Masonry layout including wall locations, heights, reinforcement size and spacing, joint location and opening information all can influence the demand placed on the masonry during construction. The 'For Construction' documents, including all addendums and bulletins, must be reviewed to

perform proper bracing analysis. The mason contractor should provide these documents, including drawings and specifications, to the bracing design engineer so that individual wall segments can be properly evaluated.

Masonry Construction Sequencing

Masonry construction sequencing is a construction means that is often first considered during bid preparation and is then refined prior to and during construction. The contractor needs to present the intended construction sequencing to the bracing design engineer regarding which walls or wall segments will be constructed first and how those walls may be supported or buttressed by other walls or constructed features. The contractor also needs to inform the bracing design engineer of the individual wall segment construction phasing in terms of how much height will be built each day, when reinforcement and grout will be placed, what type of lintels and other horizontal elements will be installed and when the final lateral support will be installed. Unreinforced masonry or reinforced masonry, prior to grout placement and/or sufficient curing, rely on masonry weight and on modest flexural tensile capacity to resist applied lateral wind loads. Reinforced masonry can take advantage of reinforcement once the grout has cured either 12 hours with extended lap lengths, or 24 hours with standard lap lengths. The sequencing of masonry lay-up and reinforcement and grout placement determines when the strength of the reinforcement can be included as the means to internally brace the wall under construction. Low lift grouting procedures should be considered because this procedure allows the wall to gain strength as the construction progresses, as discussed later in this *Guide*.

Reinforced masonry can take advantage of reinforcement once the grout has cured either 12 hours with extended lap lengths, or 24 hours with standard lap lengths.

Masonry Unit Strength

Masonry unit strength is the most common basis for determining the net area compressive strength of the masonry, commonly referred to as f'_m . During construction, masonry compressive strength is limited by the *Standard* to 50 percent of the net area compressive strength of masonry. The bracing design engineer, therefore, needs to know the compressive strength of the masonry units to be used so that the proper f'_m can be determined and then reduced by 50 percent for use in calculating the capacity of the masonry while it's under construction. A current unit compliance report or compressive strength test report should be used to verify unit strength. Preconstruction testing of units or assembled prisms should be conducted if an appropriate report is not provided or to provide verification of the compressive strength for the units and/or masonry being used.

Other Masonry Properties

Masonry thickness and density or weight per square foot influence the resisting moment for global stability and axial compressive load that combines with flexural compression or tension. Masonry unit compliance submittals will provide dimensional and density/weight criteria for evaluation and should be provided by the mason contractor.

Foundation and Soils

Foundation size including depth and geotechnical information for the project site must be shared so the influence of foundation capacity can be evaluated with regard to global stability of the wall under consideration. The bracing design engineer needs to evaluate the foundation for bearing pressure, sliding and overturning using information such as foundation geometry, the wall placement on

the foundation and the soil bearing capacity and other criteria such as active and passive pressures, friction and density.

Scheduling Control

It is also imperative to include the controlling contractor or construction manager in the communication loop. While the mason contractor and the bracing engineer are developing the final masonry installation and bracing plan, the controlling contractor or construction manager should be included to offer input where they may find schedule pinch points and to understand the intended sequencing so they can coordinate other trades. Internal bracing can provide scheduling benefits to the project due to the reduced mobilization and de-mobilization time as well as through the freeing up of the construction site in the vicinity of masonry walls under construction. It can limit trade stacking and cross trade interference – a huge benefit to the project schedule and to the controlling contractor or construction manager.

5. Modifying Requirements Shown in the Construction Documents

Many masonry wall designs that were produced for the building's final occupancy also inherently provide sufficient reinforcement to resist the short term, construction loads even when utilizing cantilevered condition analysis. Experience shows, however, that about 20 percent of walls may not be designed or detailed with sufficient capacity for resisting construction period wind loads in a cantilevered condition. In those cases, simple revisions to the design to include longer dowel lap lengths, additional wall reinforcement and/or greater foundation size and reinforcement can almost always provide the required capacity. Such changes should be submitted to the Engineer of Record and contractor for approval prior to implementation.

Foundation Dowel Lap Length

The most common capacity deficiency in design document reinforcement (with regard to its use as Internal Bracing) is insufficient dowel length to create proper lap with the vertical structural reinforcement. Foundation dowels are often kept short and the walls are designed with 'pinned' base conditions where the wall is free to rotate at the top of foundation. The shorter dowels are generally included to create a keying effect while not introducing moment into the foundation which would affect the footing design. Design engineers may be willing, when asked, to accept lengthening of the dowels to establish proper lap lengths as a trade off to consider the wall internally braced and eliminate the external braces. In fact, bracing design engineers report that as much as 50 percent of the reviewed design construction documents show long dowel laps and base fixity as part of the design, so the longer dowel laps may already be part of the original design. Most engineers will ignore the effect of the very minor base rotation that could be introduced into the foundation once the wall's permanent lateral support system is in place. Occasionally a design engineer will re-engineer the foundation, or require the bracing engineer to do so, to include the effect of the fixed base moment generated by the longer dowel laps. In those instances, footing sizes can increase and add some cost to the Internal Bracing package that may partially offset some of the savings recognized through using Internal Bracing. These costs are often minor and can be minimized if this re-design is done prior to foundation detailing and construction or, even better, during the initial engineering design rather than as an addendum after the project has been let. That cost should be considered along with the other costs when evaluating the economic efficiencies of Internal Bracing schemes. In some cases, the bracing design engineer and the Engineer of Record may be the same, if not, the bracing engineer will be responsible for verifying foundation performance for loads during the

construction period until the wall is laterally supported. Note that 48 bar diameter laps are acceptable for use during construction and allow the use of the full reinforcement capacity after 24 hours of grout curing time. A lap length of 64.8 bar diameters is required to develop the full reinforcement capacity after 12 hours of grout curing time. (see the *Standard* for more information on this parameter.)

Vertical Reinforcement Capacity

Another area where design document reinforcement can be insufficient for use in Internal Bracing schemes is the reinforcement steel area. Occasionally, the specified bar size is too small or the spacing is too great to perform sufficiently during construction wind loading. Nearly all of the walls whose design reinforcement is found lacking can be successfully upgraded to resist construction wind loading. Most commonly, existing bars can be increased in size or the specified spacing decreased to increase the flexural tension capacity. Note that, because internally braced walls are modeled as cantilevered walls where the demand is highest at the base and decreases with height, any increase in reinforcement is usually limited to a short part of the wall height above its base.

Footing Size

The least common shortcoming found in design document engineering, when considering Internal Bracing, is footing size. When properly considered for short term loading and life safety only, most existing footings provide sufficient stability. In fact, footings with a depth of 24 inches or more and a width equal to the wall thickness plus 4 inches are adequate for the majority of internally braced wall systems. If footing size is found to be lacking, adjustments can be made and submitted for approval.

6. The Role of Special Inspection

All primary structural materials and systems require Special Inspection when designed and constructed under state building codes based on the International Building Code. Those Special Inspections are key components of the public safety nature of building codes and are what allow the Codes to provide proper safety factors without building in greater levels of conservatism that was previously common for uninspected work. Masonry, like all structural systems, requires Special Inspection under IBC-based codes. Special Inspections provide assurance that specified and code mandated construction practices are followed to provide life safety for the occupancy phase of the project. They also, however, provide the same assurance for site construction personnel and the public that may occupy the space around masonry walls during the construction phase. That assurance allows construction occupancy to proceed unimpeded with non-visible, Internal Bracing methods employed. No additional inspection is required with Internal Bracing.

Section 2: Short Term Design Approach

1. General

This *Guide* is based on the *Standard* and users are required to identify additional requirements in federal, state or local safety and construction ordinances, codes and standards that apply to their specific project. Internal bracing is one method for providing temporary bracing for masonry walls under construction. Internal bracing provides the temporary support for the walls during construction while they are considered ‘unsupported.’ It is based on cantilevered performance of the wall under construction and utilizes reduced design criteria, such as lower values for the masonry’s compressive strength, for most masonry capacity calculations. Design requirements and criteria for internal and external bracing are found in the *Standard*. The *Standard* and this *Guide* are developed with the sole purpose of life safety. Protection of property, including the wall or walls under construction, is not the purpose of either document although additional design considerations for the bracing system may provide effective means to accomplish property protection.

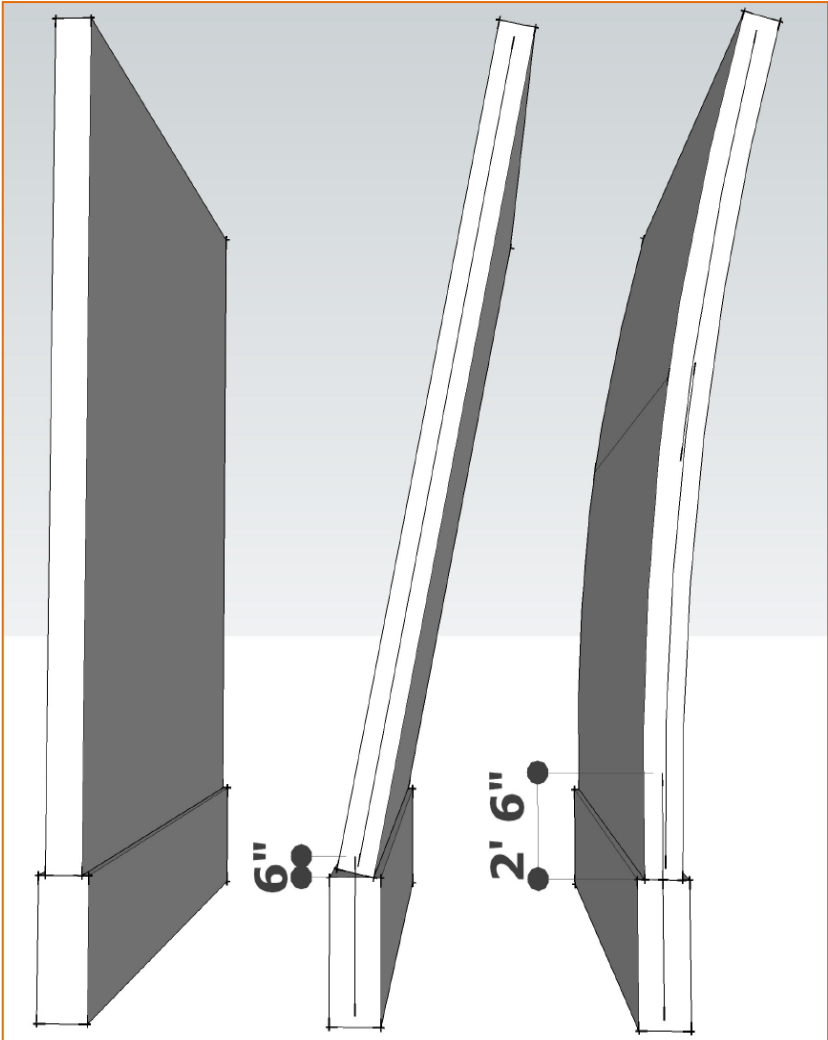

Figure 1, at the left, shows a cantilevered wall with two base doweling conditions that influence the ability of a wall to perform as internally braced. The center diagram shows a common ‘pinned’ base condition where the foundation dowel extends only 6 inches into the base of the masonry wall. This condition will provide only minimal capacity before the dowel embedment in the masonry fails and the wall becomes pinned at its base. The right side diagram shows a wall with a 2’-6” dowel (full development for a #5 bar with grout cured 24 hours). This wall will develop cantilevered capacity as the grout cures and the wall performs with base fixity and moment continuity. Assuming the structural reinforcement is sized and spaced properly, it is internally braced!

Figure 1: Cantilevered Wall Diagram

**Include a
Restricted
Zone**

One key aspect of Federal OSHA and the *Standard* is the definition of a ‘Restricted Zone,’ although the title and description may vary slightly from document to document. A Restricted Zone is required to protect persons from serious injury or death in the event of a wall failure which may be as simple as the rotation from plumb of a wall or wall segment, a unit or two that have become dis-lodged and fallen, or a wall that has partially or fully collapsed. The Restricted Zone is necessary because the temporary bracing, whether internal or external, is designed for wind speeds specified in the *Standard* that are lower than those required in the building codes. Because a relatively lower wind speed is used for bracing design, the masonry wall could become over-stressed and possibly be subject to some degree of failure during wind events when the actual wind velocities exceed the bracing design wind velocities but are less than those of the code design level winds. The *Standard* defines the Restricted Zone geometrically as being on both sides of the wall for the length of the wall plus four feet and extending away from the wall on both sides for the wall height plus four feet. That area is felt to cover the impact and ‘bounce’ zone of most walls that may collapse although it is important to note that a ‘Qualified Person’ may need to define special Restricted Zones or alternative safety measures for high rise buildings, walls where the Restricted Zone cannot be created or maintained and other situations requiring project specific consideration. The Restricted Zone must remain in place for the full duration of the Initial and Intermediate Periods.

The Standard defines the Restricted Zone geometrically as being on both sides of the wall for the length of the wall plus four feet and extending away from the wall on both sides for the wall height plus four feet.

**Design for the
Intermediate
Period**

In the *Standard*, the ‘under construction’ phase definition can be paraphrased as the entire time between the when the masonry is first laid and when the wall’s final lateral support is in place. That time period is broken into two distinct phases: The ‘Initial Period’ and the ‘Intermediate Period’ and there are different design requirements and restrictions for each. Walls are generally considered ‘unbraced’ in the Initial Period in that only the wall’s self weight is considered effective in resisting overturning and flexural stresses. Because of that, walls in the Initial Period are given prescriptive maximum heights in the *Standard* and evacuation of the Restricted Zone is required at lower wind speeds. The primary focus of Internal Bracing and this *Guide* is bracing to resist wind load during the Intermediate Period. The Intermediate Period is defined in the *Standard* as being ‘The period of time following the Initial Period until the wall is connected to the elements that provide its final lateral support.’ That can be interpreted as being the period from when the masonry is more than a day old until the wall is connected to a diaphragm or other elements that are sufficiently capable of transferring lateral force from the wall through other elements to the foundation. The intent is that the wall be connected to a continuous lateral system. Bar joists or beams bearing on or connected to the wall, without connection to a deck or even when connected to a deck, without an effective shear wall or other bracing may not qualify as ‘final lateral support’ and each project condition should be evaluated independently to determine when the Intermediate Period ends.

2. Masonry

General

Internal bracing of masonry walls under construction relies on base fixity and cantilevered construction capacity throughout the wall height during the period prior to permanent lateral support. The engineering design approach for internally bracing masonry walls under construction can be broken into two primary categories: unreinforced and reinforced masonry design. Both approaches can also be further subdivided into what are commonly referred to as high-lift and low-lift grouted walls, although unreinforced walls are rarely grouted. The common terms 'high lift' and 'low lift' don't appear in the Code and their use is somewhat inaccurate because it is really 'high pour or low pour' construction that we're talking about – pour height refers to the wall height that is constructed prior to grout placement. We're usually looking for limiting the ungrouted wall height as the construction progresses by using 'low pour' heights. The concept is to take advantage of strength that develops very quickly in constructed masonry (especially grouted masonry) and to use that strength, along with connection to the foundation, to temporarily brace the wall rather than applying an external brace system.

As noted in Section 1, certain criteria have significant impact on the Internal Bracing capacity and must be identified for each type of masonry assembly being braced. The lists to the right provide a brief summary of the most common and influential criteria, as well as others, that must be considered while designing Internal Bracing.

Unreinforced Walls

Unreinforced walls can be temporarily braced using the Internal Bracing concept. When a wall is unreinforced the only resistance to flexure is found through the units and mortar that make up the wall assembly. Analysis must consider axial and flexural tension and compression as well as global over-turning. Only the mortar bond can resist flexural tension. Therefore the bracing design engineer must know the unit size and properties, unit weight, net area unit compressive strength and mortar type and the mortar placement to be used in construction. The analysis for unreinforced masonry Internal

Table 1: Important Criteria

Unit Size and Properties

- Nominal Width: 4", 6", 8", 10", 12", 14" or 16"
- Section Properties: Area, Moment of Inertia and Section Modulus
- Unit Weight (CMU - ASTM C-90):
Lightweight (Less than 105 pcf);
Medium Weight (105 to 125 pcf);
Normal Weight (greater than 125 pcf)
- Unit Net Area Compressive Strength: 1900 psi minimum for ASTM C90 units, often more to much more - get a block test report! (Note that the minimum unit strength for concrete masonry units increases to 2000 psi beginning with C90-12.)

Mortar Type

- Type M, S or N
- Portland Cement/Lime, Mortar Cement, or
- Masonry Cement or Air Entrained Portland Cement/Lime

Reinforcement and Grout

- Bar Size
- Dowel and Lap Lengths
- Bar and Grout Spacing
- Grout Lift and Pour Height

Mortar Placement

- Face Shell Bedded
- Fully Bedded

Bracing is relatively simple and should employ a simple check for combined stresses due to gravity and wind loads: $P/A \pm M/S$. Compressive stress rarely controls Internal Bracing design, much like most occupancy designs for masonry structures, but the engineer should always check both conditions. Unreinforced walls are somewhat limited in the heights to which they can be built using Internal Bracing because the weight and flexural bond strength provide only modest capacity, especially when compared to reinforced masonry walls. Allowable flexural tensile stress (or, for Strength Design, Modulus of Rupture) values are provided for design in the *Standard*.

Adding full grout in unreinforced walls can help when ‘low pour’ procedures are employed and the grout is placed using ‘low lift procedures that allow the flexural stress values for fully grouted masonry to be used. Also consider submitting a request for adding reinforcement and partial grout if an unreinforced wall has insufficient strength for the short term Internal Bracing loads.

Submit these options for approval before proceeding with final design or installation: additional weight or the filling of cores with grout could be undesirable to the project designers...

Reinforced Walls

Reinforced walls are the best candidates for application of Internal Bracing principles due to the significant strength that the reinforcement can add as the grout cures. If the wall reinforcement is properly doweled to the foundation, base fixity can create the desired cantilevered performance. Once the grout has cured either 12 or 24 hours it has been proven to have sufficient strength to transfer tension to the reinforcement and thereby provide sufficient strength. The short term design provisions in the *Standard* are modeled after those in *Code* except that compressive stresses or strengths are reduced based on the reduction in masonry compressive strength. Analysis must consider axial and flexural tension and compression as well as global over-turning. As the wall heights increase, compression as well as foundation rotation can become a factor and should be checked. The bracing engineer must know the unit size and properties, unit weight, net area unit compressive strength and mortar type, the mortar placement and especially the reinforcement bar size and spacing to be used in construction. Using the proper net area compressive strength of masonry, in combination with the reinforcement, can provide increased benefit for resisting the construction phase wind loads.

If the reinforcement shown in the design documents proves insufficient for a cantilevered wall condition, consider increasing reinforcement size and/or decreasing reinforcement spacing. Reinforced masonry walls have been internally braced for heights in excess of sixty feet and design engineers are often open to modifying bar sizes, spacing and even foundation dowel lengths.

Submit these options for approval before proceeding with final design or installation: base fixity, weight or the filling of additional cores could be undesirable changes...

3. Foundation and Soils

Foundation analysis and, more specifically, soil capacity analysis can significantly impact the ability to use Internal Bracing. Recognizing that the demand placed on foundations is short term only, during the braced period, allows a more generous foundation evaluation when taking a life-safety approach: higher bearing pressures and minor potential rotation are acceptable because

property protection is not the primary goal of a bracing scheme. Conversely, utilizing standard bearing pressures and other geotechnical criteria that are based on long-term load and settlement concerns will limit the height to which internally braced walls can be constructed depending on footing size and soil type.

It is recommended that higher allowable bearing pressures be utilized as well as that consideration be given to passive and active pressure for providing resistance to foundation sliding and rotation. Foundation design criteria presented in geotechnical reports are typically based on controlling deflections and soil failure is rarely a concern. Safety factors on bearing pressure are often in the range of 3.0 to 4.0 or higher, so the 'ultimate' bearing capacity of the soil provides much higher capacity for short term loads.

Discuss this with the project or your favorite geotechnical engineer: soil criteria will vary with differing soil types and for different design conditions...

A common approach for bracing foundation evaluation is to take the reported allowable bearing capacity, multiply it by 3.0 and then factor it down by some smaller reduction factor such as 25% to obtain the design pressure. As an example: a 2000 psf allowable soil bearing pressure is probably based on a failure capacity of greater than 6000 psf so conservatively start there then reduce that by 25% to 4500 psf for short term foundation and soil load analysis related to the bracing system.

Remember:

The objective of Internal Bracing design is keeping the wall up during construction and long enough to provide time for evacuation during a wind event! Serviceability and protection of property is not the intended outcome when bracing is designed to the *Standard*. Internal bracing can, however, be effective for maintaining serviceability after a wind event by designing to higher or even occupancy level wind speeds.

Section 3: Internal Bracing Design

1. Analysis

Initial Period Design

During the Initial Period the mortar, and grout where applicable, have not gained sufficient strength to resist load. The walls have only their self weight available to resist overturning and flexure. As noted above, masonry walls are not considered to be braced during the Initial Period. There isn't really, then, design to be done... but there are limits to adhere to. Chapter 4 of the *Standard* contains two provisions: evacuate the Restricted Zone whenever the wind speed exceeds 20 miles per hour and the height of masonry above the base or highest line of support shall not exceed that shown in Table 4.2. The values in Table 4.2 are actually based on a 22 mph wind velocity to provide a little buffer between the evacuation wind speed and the speed at which the short term allowables may be exceeded leading to over-stress or over-load conditions. Table 4.2 is based on the lightest masonry unit density listed in the heading for the three primary columns. It is, therefore, increasingly conservative as unit density increases within the groupings and it may be beneficial to conduct analysis using the project specific unit density. The three main columns are subdivided into ungrouted hollow unit data and solid and fully grouted hollow unit data and it is important to note that interpolation is allowed for partially grouted masonry. A bracing plan should incorporate height limits for all new masonry based on the Initial Period requirements given in Chapter 4 of the *Standard*.

Intermediate Period Design

Masonry can spend a significant amount of time in the Intermediate Period, depending on when floor and roof decks are installed and when the final lateral system is fully implemented. It's a good thing, then, that masonry begins gaining strength and can often provide its own support for resisting short term loads during construction. During the Intermediate Period, the Restricted Zone must be evacuated when the wind speed exceed 35 miles per hour. That evacuation wind speed is coupled with a design wind speed of 40 miles per hour to, again, provide a time buffer to facilitate evacuation. Masonry in the Intermediate Period is characterized by being either unreinforced or reinforced. Unreinforced masonry will resist over-turning and flexure through a combination of self-weight and flexural stress or strength. Reinforced masonry can provide significant internal bracing capacity through self-weight and the tension-compression couple developed between the masonry and reinforcement. See Section 2.2 for a discussion of the design approaches.

Remember:

Reinforced masonry must have the reinforcement and grout installed **AND** the grout must have cured either 12 hours or 24 hours, depending on the length of lap splices employed. If the grout has not cured sufficiently, analyze the wall as unreinforced as noted above until the grout has cured.

Chapter 5 of the *Standard* provides in-depth requirements for Strength and Allowable Stress designs. Appendix A of the *Standard* provides tabulated summaries of values for certain block sizes and mortar types and is a nice place to gather quick design solutions for many bracing

needs. Note, however, that the tables are based on lightweight units and will be conservative for most masonry constructed in the field. Tables A1.a through A1.c provide maximum heights for unreinforced masonry walls and Tables A2.a through A2.c provide them for walls reinforced with #5 bars at 48 inches on center. Separate tables are provided for maximum unsupported height above the base or support, between braces and above the top brace. The tables use fully uniform loads for the maximum unsupported height but then switch to using an ‘effective strip’ approach once the braces are added. The tables assume that six times the thickness of the masonry wall will act with the brace to create a vertical spanning element that receives load from the remaining masonry spanning horizontally between the strips and as cantilevers of the effective strips above the braces. Efficient design can also employ distribution of some of the load to the foundation or support through 2-way action. One reference for calculating this is provided in NCMA TEK 14-3A including the graph in Figure 1.

Unreinforced masonry analysis for Internal Bracing design is readily implemented through hand calculations and spreadsheets but it is more difficult to implement through proprietary software because the software typically includes preset values for allowable flexural stress or modulus of rupture. Software designs can be achieved by working to lower thresholds when comparing calculated stresses or loads to allowable stresses or factored strength.

Reinforced masonry analysis for Internal Bracing design can also be achieved through hand calculations and spreadsheets but will have a higher degree of complication and may require iteration. Fortunately, software solutions can be more easily obtained than those for unreinforced masonry. Most software packages allow the masonry net area compressive strength to be set by the user so the appropriate value can be entered for the Intermediate Period. Because the steel can be fully developed once the grout has cured 12 or 24 hours, no change is needed for the tension portion of the analysis.

Eliminate the Restricted Zone

Another point worth discussing is that of eliminating the Restricted Zone. This can be a great tool when the Restricted Zone extends into roadways or pedestrian walkways that cannot be closed or easily protected. It can also prove highly beneficial when the Restricted Zone extends over adjacent building spaces that must remain occupied during construction. The basic premise for eliminating the Restricted Zone is to design the Internal Bracing for wind loads based on the full design level wind speed. Because the wind pressure will increase with the square of the wind velocity, the pressures will be much greater than those for the standard Intermediate Period wind speed. For example, the design pressure for a 90 mile per hour wind will be 20.7 pounds per square foot compared with 4.1 psf for the 40 mile per hour Intermediate Period wind. Note that bracing designers could implement a risk based approach through documents such as ASCE 37 where comparable exceedance probability could yield wind velocity and/or pressure less than that. Higher design wind velocities and the resulting higher pressures will more frequently require modifications to the occupancy design requirements including reinforcement quantity and possibly foundation size. Evaluate the requirements and the cost effectiveness of implementing Internal Bracing then submit the changes for approval by the designers of record.

2. Deliverables

Communication Tools

Once an Internal Bracing scheme has been evaluated and designed, it is important to properly and fully represent that design through verbal and graphic documentation. Such documentation provides the mason

contractor's field staff with explicit information regarding sequencing of construction and Restricted Zones as well as foundation, masonry and reinforcement requirements so that the design may be competently executed. Those same documents also provide opportunities for review by the prime contractor so that the masonry construction and bracing effect on the site and schedule can be understood and planned for as well as by the designers of record in case variations from the occupancy design are included. The bracing documentation also provides supplemental information for Special Inspectors to use as the basis for their inspections.

Written Content

One key element of an Internal Bracing plan is the written portion. This part of the bracing plan can provide the base assumptions and requirements for a plan represented graphically in drawings or, for simple projects, could provide the entire bracing plan. The verbal plan should first include a summary of all assumptions and conditions used by the bracing designer when analyzing the Internal Bracing design. The content should include material properties, foundation and soils criteria, masonry construction sequencing and any assumptions relative to surrounding construction or site sequencing that were utilized in the bracing design.

Graphic Content

The other, and probably more familiar, portion of a bracing plan is the graphic content. For Internal Bracing this may simply be foundation, and possibly framing plans, showing the walls and identifying the Restricted Zone. The plan(s) should include basic dimensions, notes regarding sequencing of the masonry construction and Restricted Zone implementation and should clearly show the Restricted Zone. The Restricted Zone delineation, in plan form, could go so far as to show ground and wall sign locations that will clarify the signage requirements and make the zone delineation easier to install and maintain. Another critical item that should be shown in the bracing drawings is the locations of control joints. Control joints can significantly impact wall performance by breaking horizontal continuity. Intersecting walls and corners that are used as buttresses for horizontal spans should be clearly identified so they are properly

Bracing Plan Content

Written Summary

- All base assumptions and conditions such as:
- Material properties
 - Unit strength
 - Resulting f'm and the related f'i
 - Unit size and density
 - Reinforcement and grouting
 - Mortar type and placement
- Required dowel and lap lengths
- Grout pour and lift heights
- Masonry construction sequence
- Restricted zone summary and sequence
- Foundation size and reinforcement confirmation or modification
- Soils criteria

Graphic Representation

- Plan view of all masonry walls to be braced
- Graphic representation of the Restricted Zone including:
 - dimensions
 - wall signage location
 - ground signage location
- Control joint location
- Intersecting walls and corners used as buttresses
- Changes to the occupancy design drawings that were accepted
- Consider elevation views for showing bar placement and lap locations
- Consider sections and details for showing specific requirements

constructed and sequenced. Elevations and sections or details can also be used to show important information, especially with regard to areas around openings and other points of discontinuity in the masonry. In the event that some portion of the project will require external braces, those also should be shown along with connectors and ground anchors. The plans can be made as mark-ups to the occupancy design plans or may be plans created by the bracing designer or mason contractor. Sample graphics, notes and a legend are shown in Figure 2, below, and illustrate some of the requisite items as utilized for this particular project. Finally, when changes have been proposed and accepted that modify the construction requirements shown in the occupancy design drawings, those changes must be clearly represented in the bracing plan including material requirements, sections and details as appropriate.

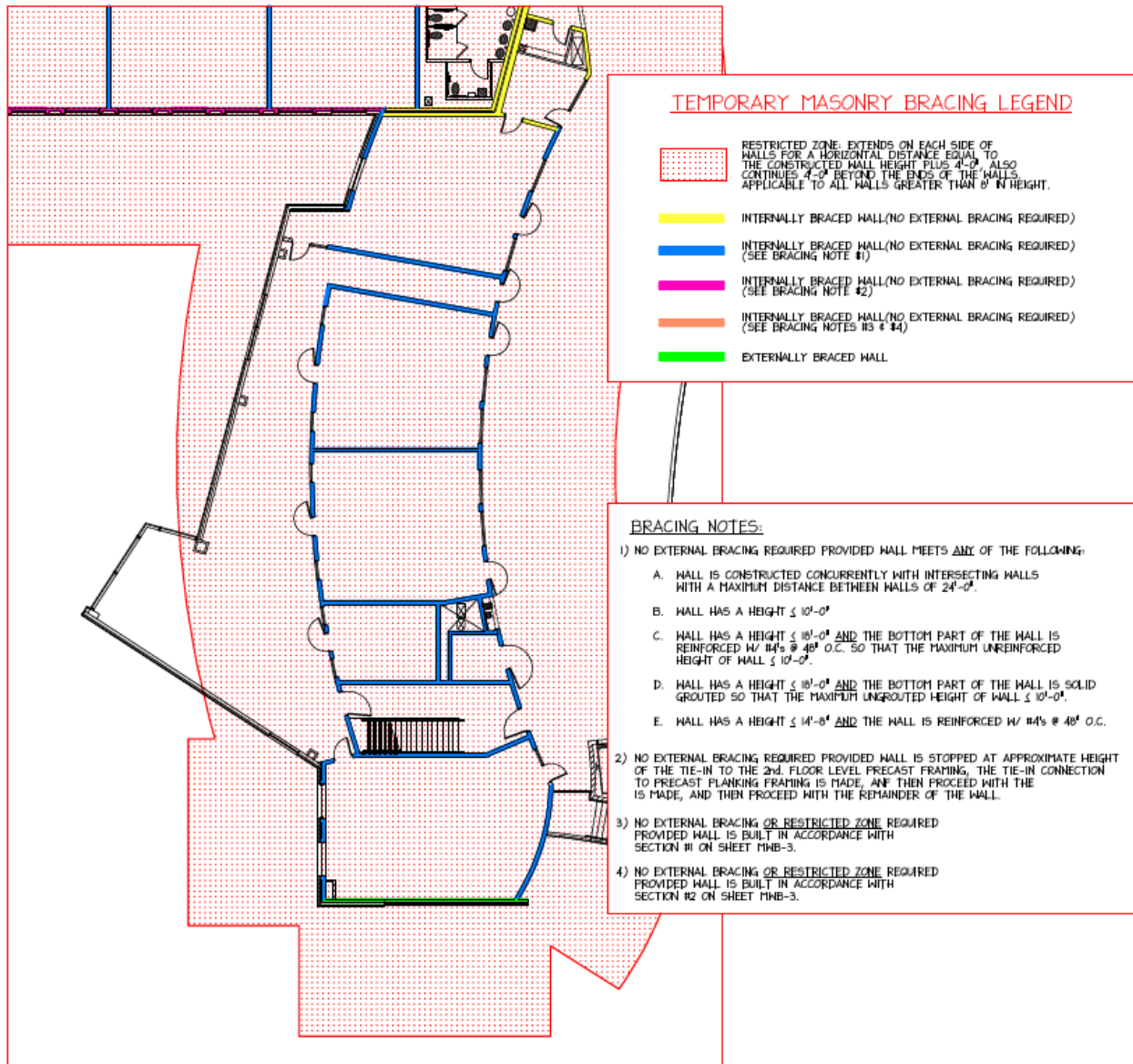

Figure 2: Sample Bracing Plan Graphics, Notes and Legend
 Reprinted with permission of Dailey Engineering, Onsted, MI

Section 4: Design Examples

The following two design examples will apply Internal Bracing concepts from the *Guide* using two different software packages. The software selected for these examples are a component design package - *Structural Masonry Design System* (SMDS), produced by NCMA and a 3-D Finite Element design package - *Ram Elements* (RE), produced by Bentley Systems. While these two software packages are not the exclusive means to analyze masonry bracing designs, they receive much input from masonry experts in their continuing development, are well known and trusted. The input and methods shown in the examples should still be applicable, even if the reader uses a different software package.

Basic Criteria

The basic criteria for each problem considered will be the same including occupancy designs based on the 2009 *International Building Code*, Intermediate Period designs based on the 2012 *Standard*, a 24'-8" length, occupancy designs with pinned bases (short reinforcement dowels only), specified f'_m of 1,500 psi, Type S Masonry Cement mortar, occupancy wind pressure of 15.0 psf, Intermediate Period wind pressure of 4.096 psf, and standard lap lengths. For our Internal Bracing concept, we'll need dowels with sufficient lap to generate a full lap length at the top of the foundation – submit that change, to the Engineer of Record through an RFI or other methods, before proceeding with design.

1. SMDS^{*1}

The SMDS example will execute an Internal Bracing design for a 28'-0" tall, 12" CMU wall designed using the occupancy criteria noted above and utilizing #6 bars at 40" on center.

2. RE^{*2}

The RE example will execute an Internal Bracing design for a 20'-0" tall, 8" CMU wall designed using the occupancy criteria noted above and utilizing #5 bars at 32" on center.

Remember:

If you plan to vary from ANY occupancy design provisions included in the project drawings or specifications – submit those changes in writing through an RFI or other appropriate device AND receive approval PRIOR to proceeding with Internal Bracing design.

Remember:

Most Internal Bracing designs will be controlled by compression in the masonry due flexure plus axial load (once base fixity has been established).

^{*1} *Structural Masonry Design System*, CMS10V5, National Concrete Masonry Association, 2010

^{*2} *Ram Elements V8i*, v13.0.2, Bentley Systems, Incorporated, 2012

1. Component Software (Structural Masonry Design System, V5.0.1)

Design Basis Menu

Begin by selecting 'Design Basis' from either the menu bar pull downs or the appropriate icon button. Then set the proper design parameters, beginning with the first tab and working left to right through the applicable tabs.

Design Codes Tab

Start with the 'Design Codes' tab and set the Code – choose 2009 IBC since the analytical requirements from the *Standard* are based on the masonry content of that code. We'll do Allowable Stress Design, but Strength Design can also be used as noted in the *Standard*. And, finally, select Concrete masonry as specified in the basic criteria.

Concrete Masonry Tab

Then move to the 'Concrete Masonry Tab'. The unit characteristics are acceptable for this example but use appropriate values based on the project units. Then make adjustments to the 'Mortar and Grout' criteria – in this case the default values are consistent with the problem parameters. The default method for 'Method for masonry strength' must be adjusted from 'Unit Strength Method' to 'Prism Test Method' and then the f'_m value must be adjusted down to reflect the Intermediate Period requirement of f'_i equaling one half of the f'_m value, in this case 750 psi.

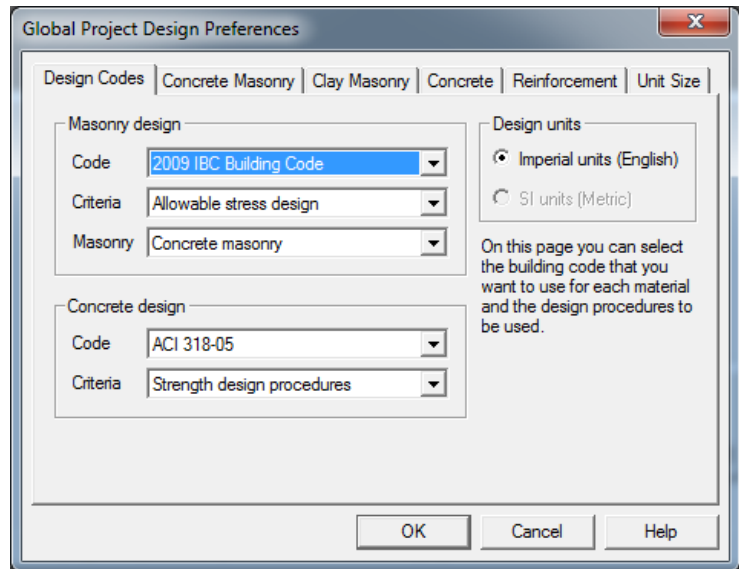

Figure 3: Design Basis Menu – Codes tab

Reprinted with Permission of National Concrete Masonry Association.

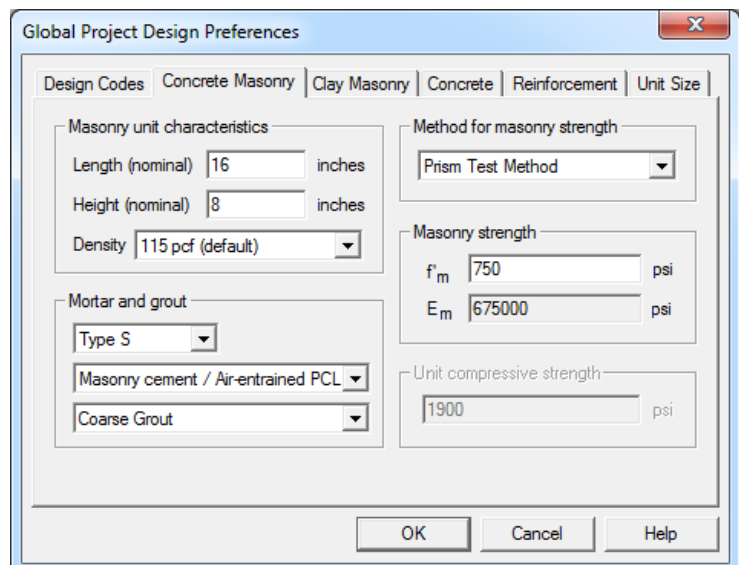

Figure 4: Design Basis Menu – Concrete Masonry tab

Reprinted with Permission of National Concrete Masonry Association.

Remember:

The *Standard* allows the use of full steel capacity after grout has cured 24 hours with the specified standard lap lengths.

Since there are no other criteria changes required, we're now ready to click 'OK' and move on to the bracing condition analysis.

Begin analysis by selecting 'Wall Design (Out-of-Plane Loads)' from the pull down menus or the 'Wall Design—Out-of-Plane' icon from the available buttons and begin the bracing design.

Design Data Tab

Make sure that the correct Code is showing and return to 'Design Basis' to make any necessary changes. Then make any other adjustments required under 'Design Criteria' – in this case the default boundary conditions need to be changed from 'Simply Supported Wall' to 'Cantilevered Wall.' Then click the check-box to turn on 'Compute using load data.'

Next, under 'Reinforcement' change the selection from the default #4 bars to the occupancy design specified #6 bars.

Finally, under 'Display Results,' change the 'Design Calculations' to 'Interaction Diagram' and leave the 'Family' setting at 'None' because we're only checking the design spacing at this point.

Don't click 'OK' yet, move to the 'Construction Data' tab.

Construction Data Tab

Here we need to enter the design data from the specified occupancy design. Edit the Wall masonry units to reflect the 12" units. Under 'Wall construction dimensions,' enter the design height of 28'-0". Do not change the 'x' value from its default setting at the wall center. Then, under 'Wall construction and spacing' change the bar spacing to the specified 40" on center. Adjust the 'Construction' data for grout and bond if the specified design is different from 'Partial grout, running bond.'

Don't click 'OK' yet, move to the 'Load Data' tab.

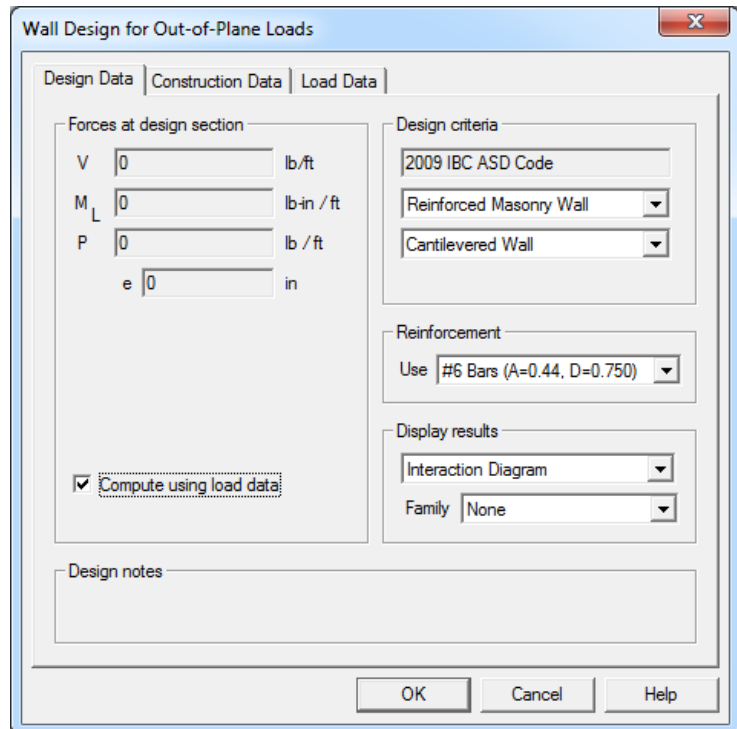

Figure 5: Out of Plane Wall Design – Design Data tab
 Reprinted with Permission of National Concrete Masonry Association.

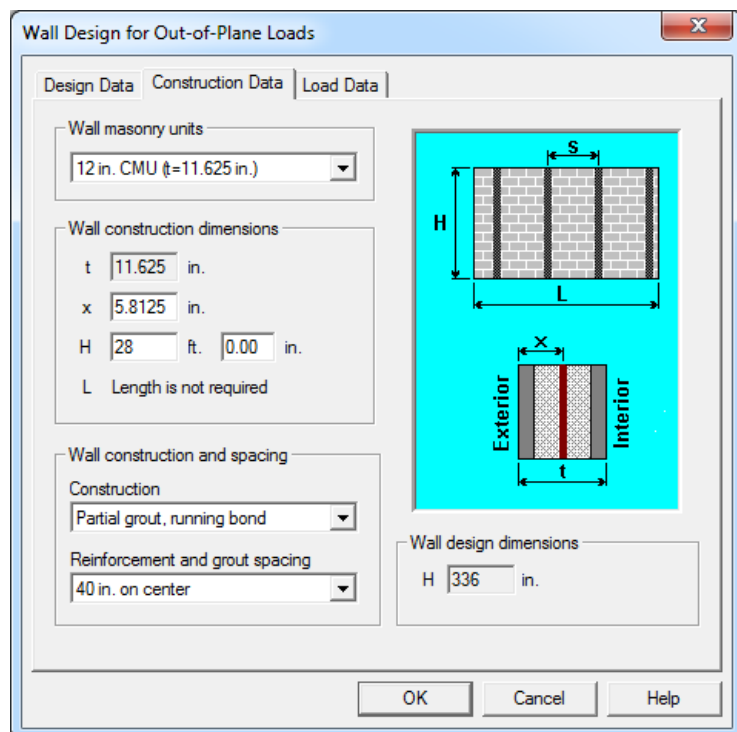

Figure 6: Out of Plane Wall Design – Construction Data tab
 Reprinted with Permission of National Concrete Masonry Association.

Load Data Tab

On this, the third and final, tab we have only one set of changes to make: Go to the ‘Wind’ tab and make the required input for our Intermediate Period wind load. Enter 4.096 in both the W_1 and W_2 data boxes. The wall will be loaded over its full height, so check to make sure that the height, in inches, is properly shown in the ‘ h_2 ’ data box.

That’s it – now click ‘OK!’

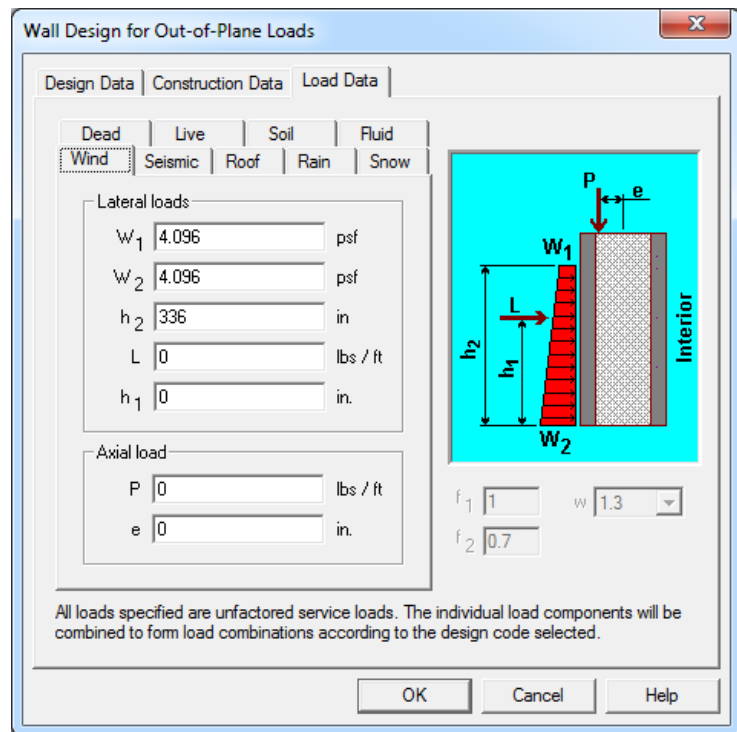

Figure 7: Out of Plane Wall Design – Load Data tab
Reprinted with Permission of National Concrete Masonry Association.

Failed Solution

Unfortunately, what you’ll see is that there are a couple data points outside the interaction diagram’s capacity curve – this is not a good solution. Now it’s time to evaluate options while trying to find an acceptable Internal Bracing solution. Possible options include larger bars, closer bar spacing and increased masonry strength.

Don’t give up – we have options! See the next page....

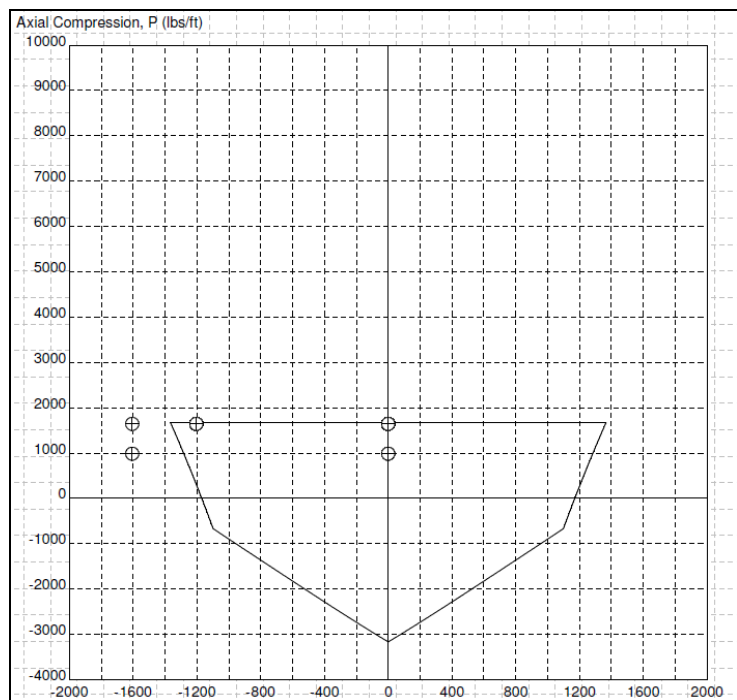

Figure 8: Analysis Results – Interaction Diagram Showing Insufficient Capacity
Reprinted with Permission of National Concrete Masonry Association.

Options

Because the masonry compressive capacity typically limits Intermediate Period masonry design, because the output data points are at or near the compressive stress limit and because the flexural capacity will also increase with increased masonry strength, let's look at the value of f'_i that was input for the f'_m back in 'Design Basis.' Recall that the occupancy design documents specified an f'_m of 1,500 psi and our bracing design was required to use 50% of that value, or 750 psi. Block manufacturers in most of the country regularly produce units with compressive strengths well in excess of the ASTM C90 minimum, let's take advantage of that. Check with the supplier being used by the masonry contractor or with those being considered and ask about their standard unit strengths. You will probably find unit strengths at least in the high 2,000's, probably in the 3,000's and often in excess of 4,000 psi.

Block manufacturers in most of the country regularly produce units with compressive strengths well in excess of the ASTM C90 minimum, let's take advantage of that.

Final Solution

For this example, we find that a simple change of f'_m from half of 1,500 psi to half of 2,500 psi (unit compressive strength of 3,750 psi) provides acceptable results. So, go back to 'Design Basis' and under the Concrete Masonry tab, change f'_m to 1,250 psi to properly represent half of the actual masonry compressive strength of 2,500 psi.

Click OK.

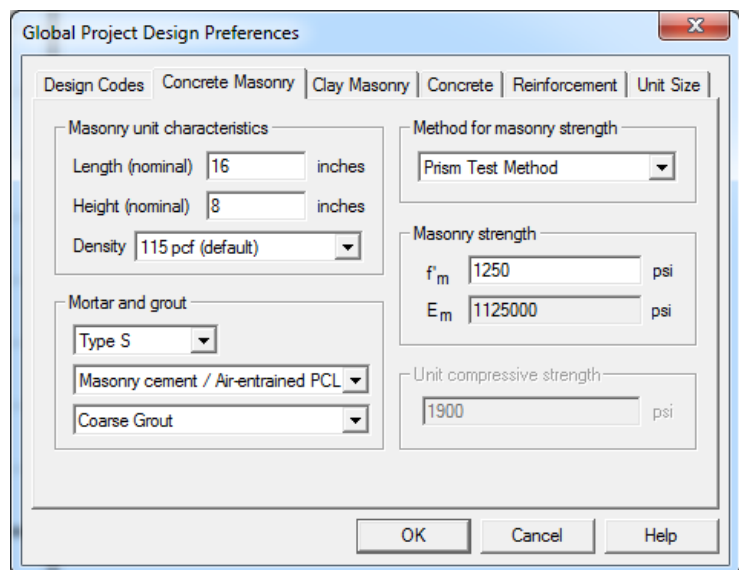

Figure 9: Return to Design Basis – Modify masonry strength
Reprinted with Permission of National Concrete Masonry Association.

Then, go to the 'Edit Design' option under the pull-down menu or with the icon button, without making any other changes and...

Click OK.

No changes were made and we have a final solution that works!

You'll clearly see that the data points all now comfortably fall within the capacity curve. By using the available unit strength rather than the lower, specified strength we now have an acceptable solution! Also, note that the reinforcement bar size and spacing that satisfied the occupancy demand in a pinned-pinned configuration also satisfies the temporary bracing demand for the Internal Bracing concept.

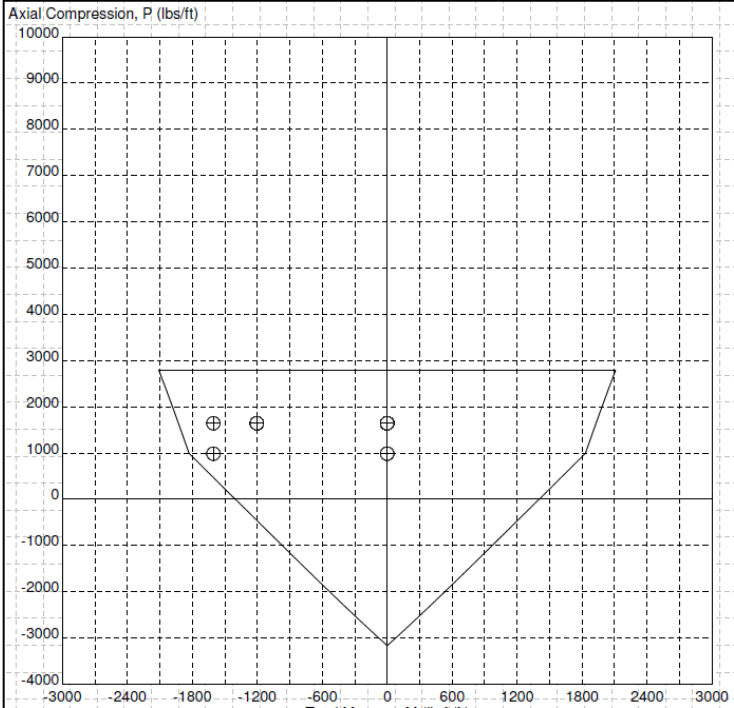

Figure 10: Analysis Results – Interaction Diagram Showing Sufficient Capacity
Reprinted with Permission of National Concrete Masonry Association.

2. Finite Element (Ram Elements)

Begin by opening Ram Elements. The software will open into its 3-D modeling window. You could construct a wall in this environment using nodes and shells but we're going to conduct our work in the 'Wall Module' where simple walls, even those with openings, can be modeled.

Create New Material

But, first.... Don't go to the 'Wall Module,' yet. We need an appropriate material to work with and that needs to be created in the main RE window. Remember, the reinforcement capacity can be fully considered with normal lap lengths once the grout has cured at least 24 hours – no change to the steel properties are required. A proper masonry material, to represent the Intermediate Period masonry, must be created. Under the 'Home' tab, go to the 'Material' database and create a new

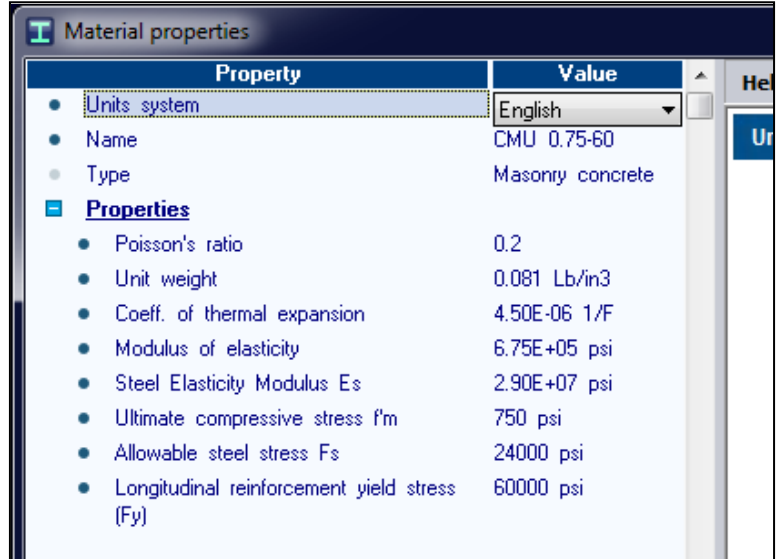

Property	Value
Units system	English
Name	CMU 0.75-60
Type	Masonry concrete
Properties	
Poisson's ratio	0.2
Unit weight	0.081 Lb/in3
Coeff. of thermal expansion	4.50E-06 1/F
Modulus of elasticity	6.75E+05 psi
Steel Elasticity Modulus Es	2.90E+07 psi
Ultimate compressive stress f'm	750 psi
Allowable steel stress Fs	24000 psi
Longitudinal reinforcement yield stress (Fy)	60000 psi

Figure 11: Data Input Field - Masonry Properties

Reprinted from Ram Elements V8i with permission of Bentley Systems Incorporated

material. You may base your new material off of one of RE's existing materials by copying one, pasting it into your user briefcase and then editing the title and appropriate properties. The only properties that must be changed are the 'Modulus of elasticity' and the 'Ultimate compressive stress f'_m '. Choose appropriate values for the f'_i that you'll be using then make and save the changes. The graphic shows appropriate saved values for an f'_i of 750 psi (for $f'_m = 1,500$ psi). You may also want to change the 'Unit weight' value, depending on the actual weight of your masonry assembly (unit and grout considered together).

Now we're ready to click on 'Modules' and select 'Standalone' from the 'Walls' section. There, select 'Masonry' and the masonry wall module will open.

Code and Geometry Data

First, select the appropriate design code. For this example we will use the 2008 TMS 402 masonry code which is what the 2009 IBC incorporates by reference and will most closely match the approach used in the prior example. Note that additional efficiencies may be found by using the 2011 ASD provisions when appropriate or with approval of the building official. Then make the appropriate changes to the 'Geometry' criteria including height, length, block size and especially

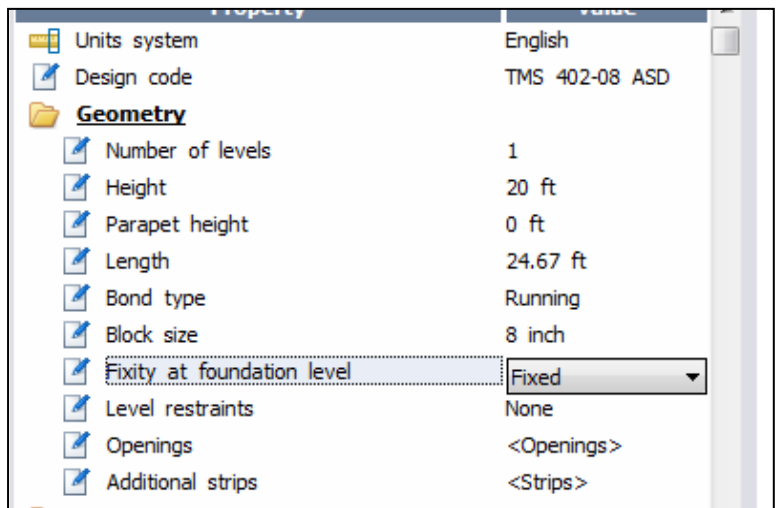

Property	Value
Units system	English
Design code	TMS 402-08 ASD
Geometry	
Number of levels	1
Height	20 ft
Parapet height	0 ft
Length	24.67 ft
Bond type	Running
Block size	8 inch
Fixity at foundation level	Fixed
Level restraints	None
Openings	<Openings>
Additional strips	<Strips>

Figure 12: Data Input Field - Geometry

Reprinted from Ram Elements V8i with permission of Bentley Systems Incorporated

‘Fixity at foundation level’ and ‘Level restraints.’ We need to utilize ‘Fixed’ base conditions and remove the support at the roof level by changing the setting to ‘None.’ The changes should show up in the graphics window.

Materials Data Next, we need to change the materials to match our Intermediate Period design. First, change the ‘Material’ to the newly created masonry material – in this case we’re using the one created above for CMU with an f'_m of 1,500 psi and an f'_i of 750 psi. Make changes to the mortar, grouting and bedding criteria, also, as required.

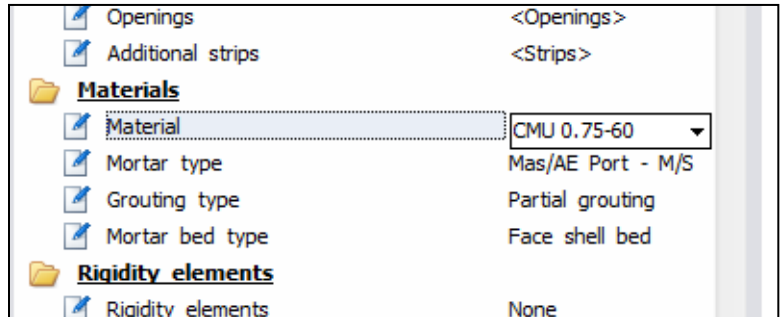
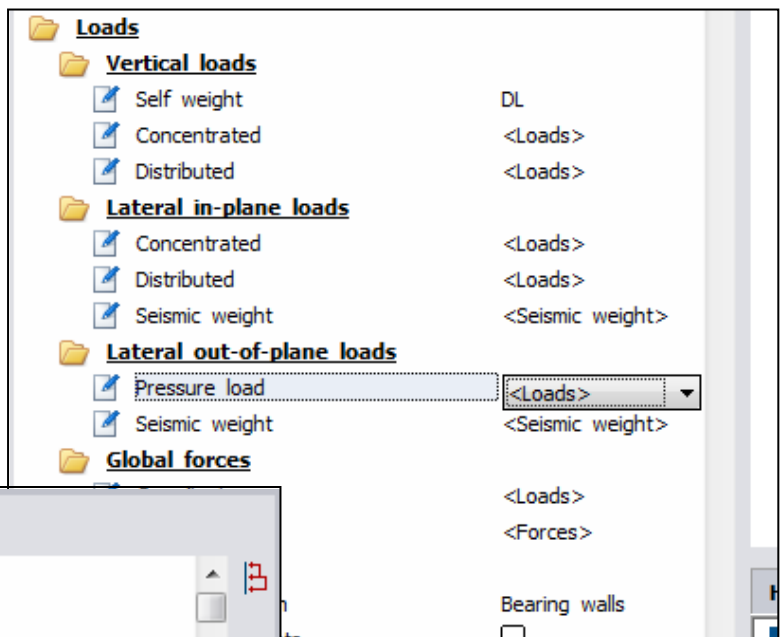

Figure 13: Data Input Field - Masonry Criteria
Reprinted from Ram Elements V8i with permission of Bentley Systems Incorporated

Load Data Now it’s time to apply our loads – no changes are required except to enter our Intermediate Period wind load in the ‘Pressure Load’ data box under ‘Lateral out-of-plane loads.’ So click on ‘Loads’ next to ‘Pressure load’ and enter the 4.096 psf required for the Intermediate Period.



Num	Level	Load case	Magnitude
1	1	WL	4.096

Figure 14: Data Input Field - Loads
Reprinted from Ram Elements V8i with permission of Bentley Systems Incorporated

Design Data

Finally, make adjustments to the default data under ‘Design data.’ Begin by turning off the check-boxes for all ‘Elements to design’ except for ‘Bearing walls.’ Leave the check for ‘Reinforced walls’ and keep ‘One’ for ‘Reinforcement layers.’ Designing to ‘Bar size’ is appropriate since we’re trying to match the occupancy design but you could also change ‘Design criterion’ to ‘Spacing’ if you’d like to see what bar size would be required at the design spacing. And, finally, select the appropriate bar size – a #5 for our purposes.

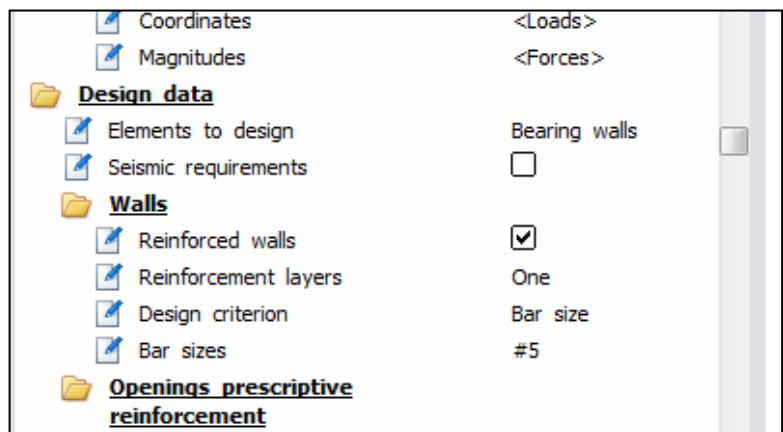

Figure 15: Data Input Field – Design Data

Reprinted from Ram Elements V8i with permission of Bentley Systems Incorporated

Analysis

Now it’s time to check our design. You can click ‘Optimize’ and let the software determine the best bar spacing or size to fit your input data or click ‘Check’ to get a pass-fail analysis on the specific size and spacing that were input. Let’s click ‘Optimize’ for this project and see what happens. We first note the ‘green light’ in the lower right corner indicating that an appropriate solution was found. We can view the specifics of that solution in ‘Detailing’ at the top menu bar or click ‘Report.’ I prefer to see a full report including stress ratios and other data, so let’s click ‘Report.’ The key data is on the second page of the report and shows that the wall can be made to work in a cantilevered condition, but would require #5’s at 8” on center. While that could be an alternative design to consider, it requires bars much closer than the specified 32” on center and would need to be submitted for a change. Based on cost and practicality it’s probably not the best solution!

Vertical reinforcement:					
Segment	Bars	Spacing [in]	Ld [in]		
1	37-#5	8.00	55.63		

Results: Combined axial flexure					
Segment	Condition	P [Lb]	M [Lb*ft]	Ma [Lb*ft]	Ratio
1	D3(Bottom)	13507.97	20206.90	21851.09	0.92 

Figure 16: Analysis Report – Good bar size, excessive bar spacing

Reprinted from Ram Elements V8i with permission of Bentley Systems Incorporated

Re-Analysis and Final Solution

So, we need to make some adjustments to this Internal Bracing design, also. See the notes in Section 1, above, regarding possible ways to increase the strength sufficiently. For this example we'll also look to a more realistic value of f'_m and f'_i rather than the specified 1,500 psi. By adjusting only the f'_m , from 750 to 1,250 psi, we again find that this internal wall bracing design can work in a cantilevered condition with the bar size and spacing specified for the pinned-pinned occupancy design.

Vertical reinforcement:			
Segment	Bars	Spacing [in]	Ld [in]
1	10-#5	32.00	43.09

Results: Combined axial flexure					
Segment	Condition	P [Lb]	M [Lb*ft]	Ma [Lb*ft]	Ratio
1	D3(Bottom)	13507.97	20206.90	21812.28	0.93 

Figure 17: Analysis Report – Good bar size and spacing
 Reprinted from Ram Elements V8i with permission of Bentley Systems Incorporated

Section 5: Concluding Remarks

Masonry walls must be braced while they are under construction to provide safety to construction workers and other persons that may occupy the space adjacent to those walls. The *Standard Practice for Bracing Masonry Walls Under Construction* provides the engineering basis for analyzing bracing methods for masonry walls under construction. The two most common methods are the more historical ‘external’ bracing and the newer ‘internal’ bracing concept. Internal bracing utilizes the strength provided by the wall as it is being constructed without relying on external components. Cooperation with, and collaboration between, bracing design engineers, mason contractors and controlling contractors or construction managers are critical and can yield highly efficient Internal Bracing schemes with significant benefit to projects in terms of safety, schedule and cost. This *Guide* has provided information and direction, gained through experience by the author and others experienced in the design of Internal Bracing for masonry walls. It includes application examples to assist bracing designers in understanding and applying this engineered method. It is hoped that users will employ this method and the content of this *Guide* to efficiently design Internal Bracing for masonry walls under construction.